

JVC



COMPACT COMPONENT SYSTEM

VS-DT6

Consists of CA-VSDT6 and SP-VSDT6

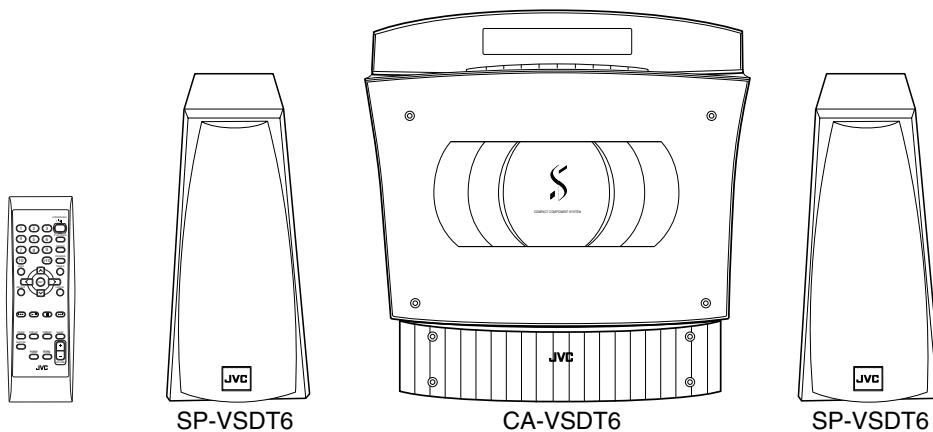

COMPACT
disc
DIGITAL AUDIO

INSTRUCTIONS

For Customer Use:

Enter below the Model No. and Serial No. which are located either on the rear, bottom or side of the cabinet. Retain this information for future reference.

Model No. _____

Serial No. _____

LVT0853-008A

[A]

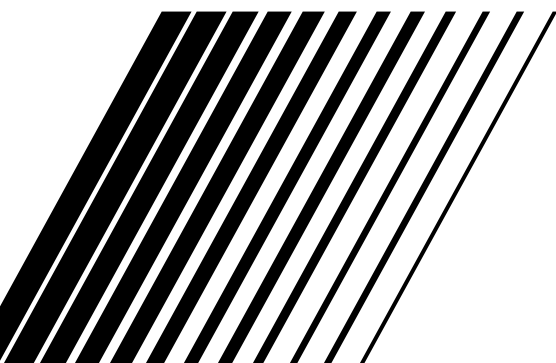

Warnings, Cautions and Others

Caution — switch!

Disconnect the mains plug to shut the power off completely (the  goes off).

The  switch in any position does not disconnect the mains line.

- When the unit is on standby, the  lights red.
- When the unit is turned on, the operation lamps light red.

The power can be remote controlled.

CAUTION

To reduce the risk of electrical shocks, fire, etc.:

- 1 Do not remove screws, covers or cabinet.
- 2 Do not expose this appliance to rain or moisture.

CAUTION

1. Do not block the ventilation openings or holes.
(If the ventilation openings or holes are blocked by a newspaper or cloth, etc., the heat may not be able to get out.)
2. Do not place any naked flame sources, such as lighted candles, on the apparatus.
3. When discarding batteries, environmental problems must be considered and local rules or laws governing the disposal of these batteries must be followed strictly.
4. Do not expose this apparatus to rain, moisture, dripping or splashing and that no objects filled with liquids, such as vases, shall be placed on the apparatus.

Caution: Proper Ventilation

To avoid risk of electric shock and fire, and to prevent damage, locate the apparatus as follows:

- 1 Top: No obstructions and open spacing.
- 2 Sides/ Front/ Back: No obstructions should be placed in the areas shown by the dimensions below.
- 3 Bottom: Place on the level surface. Maintain an adequate air path for ventilation by placing on a stand with a height of 10 cm or more.

CAUTION

■ About the Internal Cooling Fan

This unit includes an internal cooling fan, so as to allow for high-power operation within a small space.

This fan comes on when the sound level is set high, and may also come on even at low sound levels if the internal temperature rises. To ensure effective fan operation, please leave at least 1cm clearance on each side of the unit.

IMPORTANT FOR LASER PRODUCTS

REPRODUCTION OF LABELS

- 1 CLASSIFICATION LABEL, PLACED ON EXTERIOR SURFACE

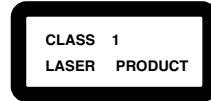

- 2 WARNING LABEL, PLACED INSIDE THE UNIT

CAUTION: Invisible laser radiation when open and interlock failed or defeated. AVOID DIRECT EXPOSURE TO BEAM.	ADVARSEL: Usynlig laserstråling ved åbning, når sikkerhedsafbrydere er ude af funktion. Undgåudsætelse for stråling. (e) Helse for stråling.	VARNING: Osynlig laserstråling når denna del är öppenad och spärren är urkopplad. Beträkta ej strålen. (d)	VARO: Avattaessa ja suojalettiä näkymättömällä lasersäteilyllä. Älä katso säteeseen. (s)
--	---	---	---

- 1 CLASS 1 LASER PRODUCT

- 2 **CAUTION:** Invisible laser radiation when open and interlock failed or defeated. Avoid direct exposure to beam.
- 3 **CAUTION:** Do not open the top cover. There are no user serviceable parts inside the Unit; leave all servicing to qualified service personnel.

Front view

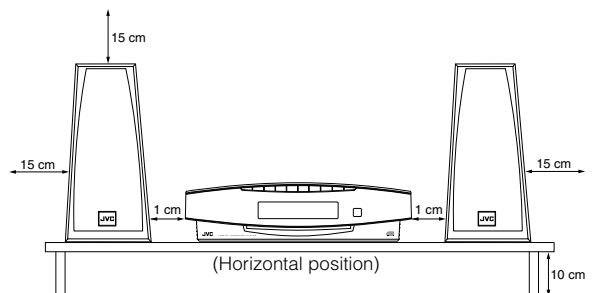
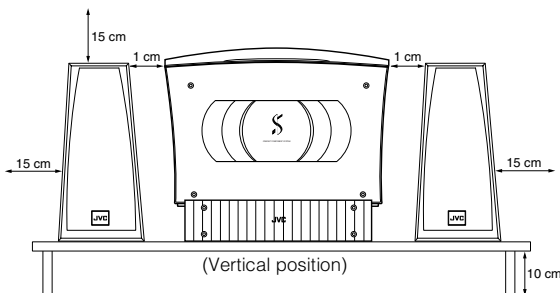

Introduction

Thank you for purchasing the JVC Compact Component System.
We hope it will be a valued addition to your home, giving you years of enjoyment.
Be sure to read this instruction manual carefully before operating your new stereo system.
In it you will find all the information you need to set up and use the system.
If you have a query that is not answered by the manual, please contact your dealer.

Features

Here are some of the things that make your System both powerful and simple to use.

- With the slot-loading CD mechanism, you can choose to place the System either vertically or horizontally.
- The controls and operations have been redesigned to make them very easy to use, freeing you to just enjoy the music.
 - With JVC's **COMPU PLAY** you can turn on the System and automatically start the Radio or CD Player with a single touch.
- The System incorporates Active Hyper Bass PRO circuitry to faithfully reproduce low frequency sounds.
- A 45-station preset capability (30 FM and 15 AM) in addition to auto-seek and manual tuning.
- CD options that include repeat, random and program play.
- Timer functions; Daily Timer and Sleep Timer.
- You can connect various external units, such as an MD recorder.
- The system can play CD-R and CD-RW after they have been **finalized**.
- You can play back your original CD-R or CD-RW recorded in Music CD format. (However they may not be played back depending on their characteristics or recording conditions.)



How This Manual Is Organized

- Basic information that is the same for many different functions - e.g. setting the volume - is given in the section 'Basic Operations', and not repeated under each function.
- The names of buttons/controls and display messages are written in all capital letters: e.g. FM/AM, "CD NO DISC".
- System functions are written with an initial capital letter only: e.g. Normal Play.

Use the table of contents to look up specific information you require.

We have enjoyed making this manual for you, and hope it serves you in enjoying the many features built into your System.

WARNINGS

- **DO NOT PUT ANYTHING ON THE PANEL. IF THE SYSTEM IS OPERATED WITH SOMETHING PUT ON THE PANEL, IT WILL BE DAMAGED WHEN YOU TRY TO OPEN THE PANEL.**
- **SUPPLIED SPEAKERS ARE EXCLUSIVELY FOR THIS SYSTEM. USING WITH OTHER DEVICES WILL DAMAGE THE SPEAKERS.**

IMPORTANT CAUTIONS

1 Installation of the System

- Select a place which is level, dry and neither too hot nor too cold. (Between 5°C and 35°C or 41°F and 95°F.)
- Leave sufficient distance between the System and a TV.
- Do not use the System in a place subject to vibrations.

2 Power cord

- Do not handle the power cord with wet hands!
- Some power is always consumed as long as the power cord is connected to the wall outlet.
- When unplugging the System from the wall outlet, always pull the plug, not the power cord.

3 Malfunctions, etc.

- There are no user serviceable parts inside. In case of system failure, unplug the power cord and consult your dealer.
- Do not insert any metallic object into the System.
- Do not insert your hand between the Panel and the main body when the Panel is being closed.

Table of Contents

Introduction	1
Features	1
How This Manual Is Organized	1
WARNINGS	1
IMPORTANT CAUTIONS	1
Getting Started	3
Accessories	3
How To Put Batteries In the Remote Control	3
Connecting the FM Antenna	4
Connecting the AM Antenna	5
Connecting the Speakers	6
Connecting a Subwoofer	7
Connecting External Equipment	7
Connecting an MD Recorder, etc (Digital Output)	8
Connecting the AC Power Cord	8
Installing the Unit on the Stand	8
Installing the Equipment on the Wall	9
Changing the Display and Control Buttons Settings	10
Using the Remote Control	11
COMPU Play	11
Basic Operations	12
Turning the Power On and Off	12
Adjusting the Brightness (DIMMER)	12
Adjusting the Volume	13
Reinforcing the Bass Sound (AHB PRO)	13
Tone Control (BASS/TREBLE)	13
Showing the Time (DISPLAY)	13
Using the Tuner	14
Tuning In a Station	14
Presetting Stations	15
To Change the FM Reception Mode	15
Using the CD Player	16
To Insert a CD	16
To Unload a CD	17
Basics of Using the CD Player — Normal Play	17
Programming the Playing Order of the Tracks	17
Random Play	18
Repeating Tracks	18
Child Lock	18
Using External Equipment	19
Listening to External Equipment	19
Recording the System's Source to External Equipment	19
Using the Timers	20
Setting the Clock	20
Setting the Daily Timer	21
Setting the SLEEP Timer	22
Care And Maintenance	23
Troubleshooting	24
Specifications	25

Getting Started

Accessories

Make sure that you have all of the following items, which are supplied with the System.

- Power Cord (1)
- AM Loop Antenna (1)
- Remote Control (1)
- Batteries (2)
- FM Wire Antenna (1)
- Speaker Cords (2)
- Stand (1) (for Center Unit)
- Legs (2) (for Stand)
- Screw (1) (for Stand)
- Paper Pattern (1)

If any of these items are missing, contact your dealer immediately.

How To Put Batteries In the Remote Control

Match the polarity (+ and -) on the batteries with the + and - markings in the battery compartment.

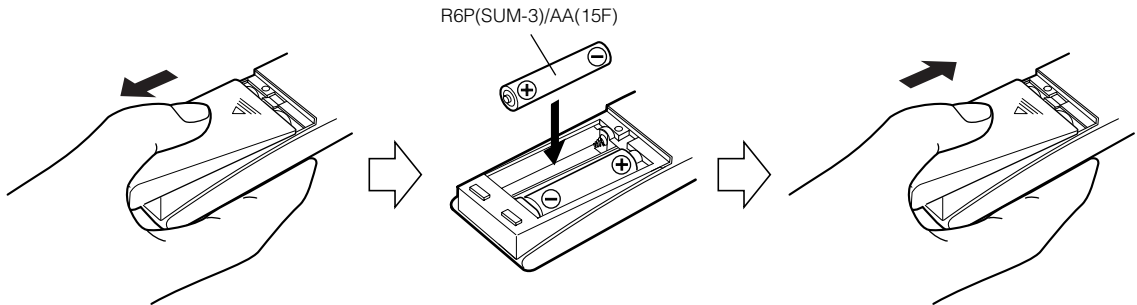

CAUTION:

- Handle batteries properly.

■ To avoid battery leakage or explosion:

- Remove batteries when the Remote Control will not be used for a long time.
- When you need to replace the batteries, replace both batteries at the same time with new ones.
- Do not use an old battery with a new one.
- Do not use different types of batteries together.

Getting Started

CAUTION:

- Make all connections before plugging the System into an AC power outlet.



(Only if you install the Center Unit vertically)

- To place the Center Unit **vertically**, the Stand and Legs must be attached. (See page 8.) To make connections, let the cords pass in the holes of the Stand as shown in the diagram before attaching the Stand and Legs.

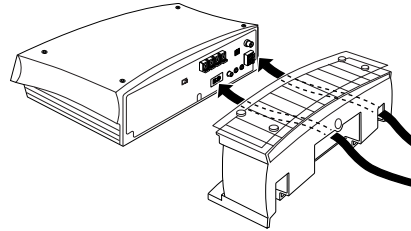

Connecting the FM Antenna

Rear Panel of the Center Unit

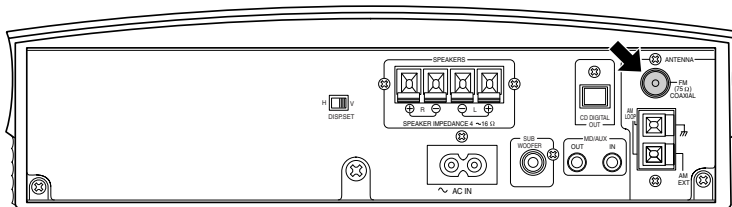

Using the Supplied Wire Antenna

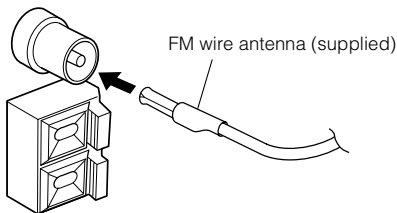

If reception is poor, connect the outdoor antenna.

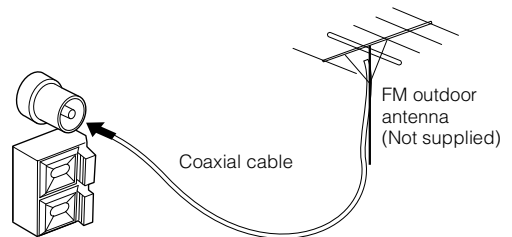

Using the Coaxial Type Connector (Not Supplied)

A 75 Ω antenna with coaxial type connector (IEC or DIN45 325) should be connected to the FM 75 Ω COAXIAL terminal.

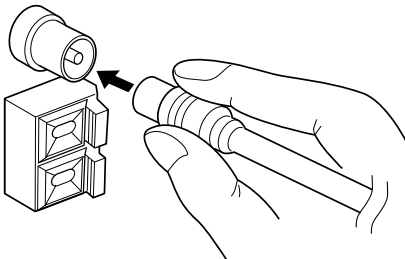

- Before attaching a 75 Ω coaxial lead (the kind with a round wire going to an outdoor antenna), disconnect the supplied FM Wire Antenna.

Connecting the AM Antenna

Rear Panel of the Center Unit

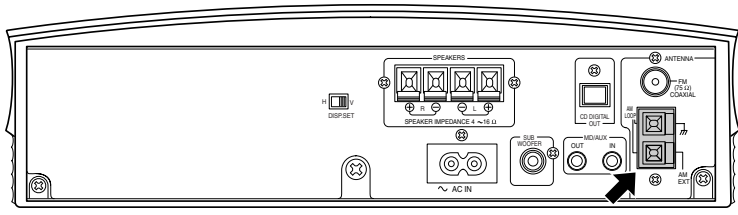

AM loop antenna (Supplied)

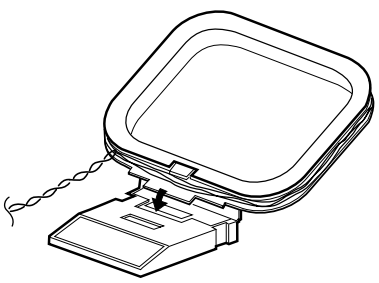

Attach the AM loop to its base by snapping the tabs on the loop into the slot in the base.

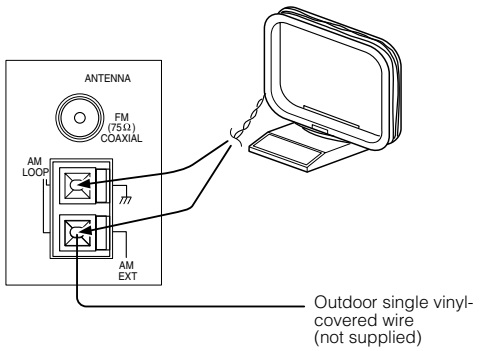

Turn the loop until you have the best reception.

• The AM loop antenna can be attached to a wall.

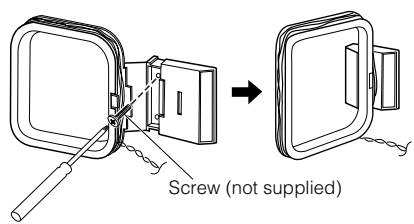

Notes

- If the AM loop antenna wire is covered with vinyl, remove the vinyl by twisting it as shown in the diagram.
- Make sure the antenna conductors do not touch any other terminals, connecting cords and power cord. This could cause poor reception.
- If reception is poor, connect an outdoor single vinyl-covered wire to the AM EXT terminal. (Keep the AM loop antenna connected.)



CAUTION:

- Make all connections before plugging the System into an AC power outlet.
- Handling the speakers
As this is a precision instrument, handle it carefully so as to protect it from shocks.

Connecting the Speakers

These speakers are exclusively for this system. Using with other devices will damage the speakers.

1. Open each of the terminals to connect the speaker wire leads.
2. Connect the speaker cords between the Speaker terminals of the Unit and the terminals of the Speakers.
Connect the cords with a black line to the (-) terminals and cords without a black line to the (+) terminals.
3. Close each of the terminals to securely connect the cords.

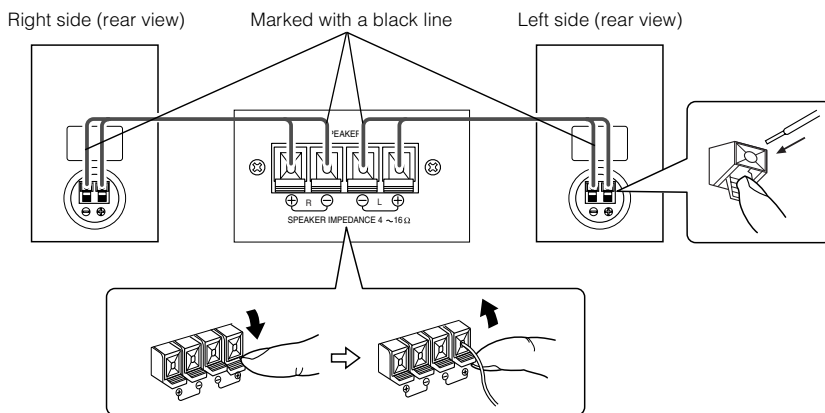

Notes

- Since both speakers are the same, you can put either one to the right or left side.
- Do not connect other speakers to the Unit. The difference of the load impedance causes failures.
- Do not use the supplied speakers in parallel with other speakers.

CAUTION:

- A TV may display irregular colors if located near the speakers. If this happens, set the speakers away from the TV.

Removing the speaker grilles

The speaker grilles can be removed.

When removing:

1. Pull the bottom towards you with your fingers.
2. Also pull the top towards you.

When attaching the speaker grilles:

Attach the speaker grilles as shown in the diagram.

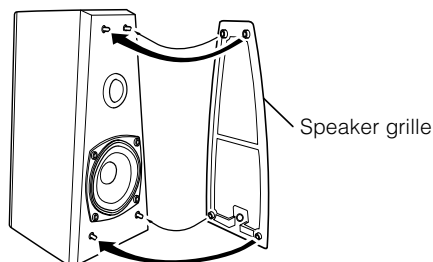
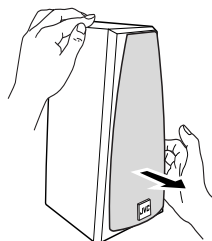

Connecting a Subwoofer

Connect a signal cord (not supplied) between the System's SUBWOOFER terminal and the input terminal of an external subwoofer.

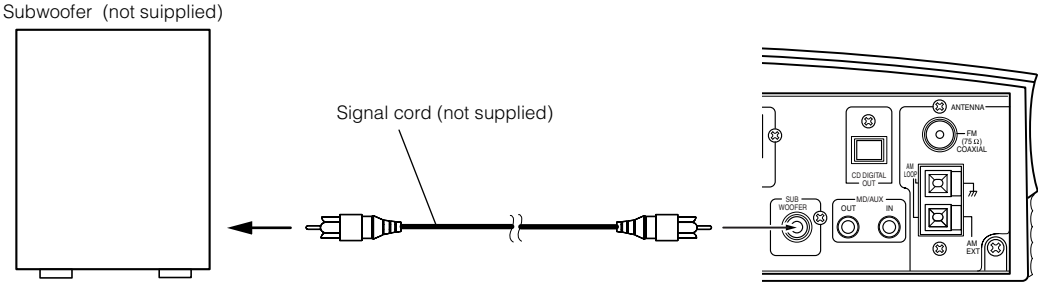

Connecting External Equipment

Connect signal cords (not supplied) between the System's MD/AUX-OUT/IN terminals and the output/input terminals of the external MD recorder, tape deck, etc.

You can then listen to the external source through the System or record the System's CD player or tuner to the external unit.

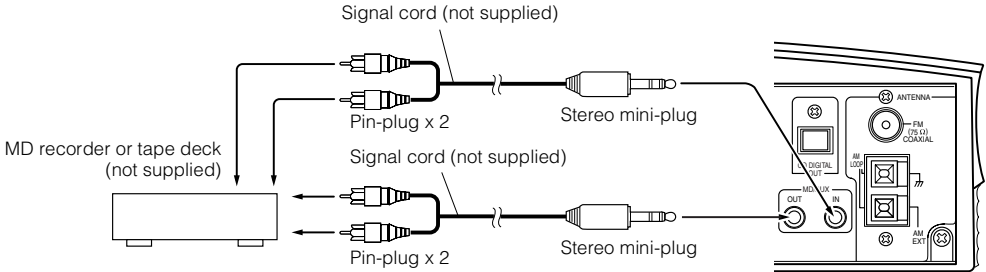

Connecting an MD Recorder, etc (Digital Output)

Remove the cap and connect an optical digital cord (not supplied) between the System's CD DIGITAL OUT terminal and the input terminal of the MD recorder, etc.

You can record the digital output signal from the System's CD Player to the MD recorder, etc.

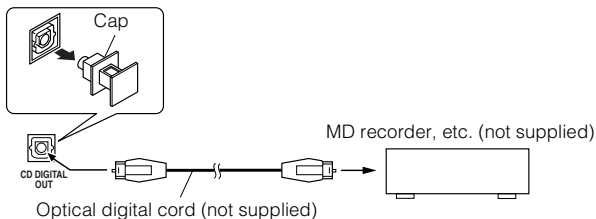

Connecting the AC Power Cord

Firmly insert the supplied AC power cord into the AC inlet on the back of the Unit.

CAUTIONS:

- ONLY USE THE JVC POWER CORD PROVIDED WITH THIS SYSTEM TO AVOID MALFUNCTION OR DAMAGE TO THE SYSTEM.
- BE SURE TO UNPLUG THE POWER CORD FROM THE OUTLET WHEN GOING OUT OR WHEN THE SYSTEM IS NOT IN USE FOR AN EXTENDED PERIOD OF TIME.

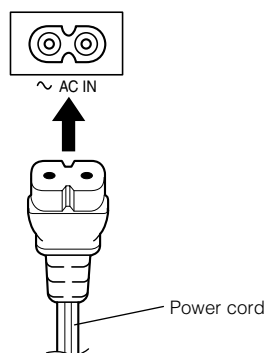

Installing the Unit on the Stand

You can place the Unit **vertically** by attaching the supplied Stand.

Attach the Stand to the Unit and tighten the screw.

Attach the Legs to the Stand.

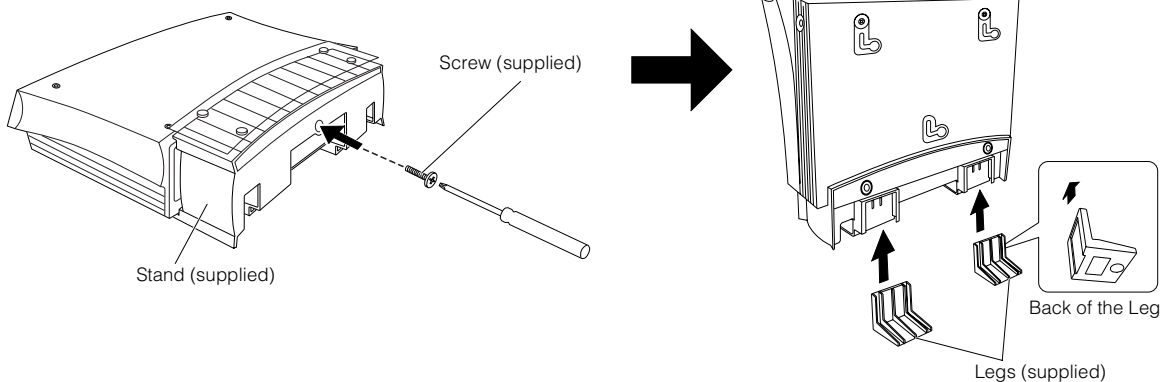

- Avoid an unstable place when placing the Unit vertically. Select a place on the level surface.

Installing the Equipment on the Wall

The Center Unit and Speakers can be attached to a wall.

CAUTIONS:

Attachment to a wall

- The Center Unit weighs approximately 4.3 kg. When its buttons are operated, an additional force will be applied to it in the downward direction. Therefore, sufficient care must be taken when attaching to a wall to prevent any accidents caused by the Center Unit's falling off the wall.
- Before attaching the Center Unit to the wall, check the wall and other related aspects, and verify whether the strength of the wall will be sufficient not only to support the weight of the Center Unit itself but also to withstand the additional downward force which will be applied to it during operation. (Do not attach the Center Unit to a plywood or plasterboard wall. The Center Unit may fall and sustain damage as a result.) If you do not know the strength of the wall and other aspects, consult a qualified service person (such as a qualified constructor).
- The screws needed for attachment are not supplied. Use screws which are compatible with the strength and material of the pillar or wall.
- When attaching the Center Unit, the screws must be secured tightly in all three locations. Attaching the Center Unit to the wall by making only one or two holes for the screws makes for an unstable attachment and causes a safety hazard as the Center Unit may fall down.

Location of attachment to a wall

- Care is required in selecting a location for attaching the Center Unit to the wall. Injury to personnel, or damage to the Center Unit, may result if the Center Unit is attached in a location which interferes with daily activities or a location that the users are liable to knock their bodies or heads against.
- Avoid a location above a bed, sofa, water tank, sink, etc. or in a passage.

Example of attachment (Center Unit)

The procedure below is intended merely to illustrate how the Center Unit can be attached to a wall and does not make any guarantees for safety while using the Center Unit on a wall. Take into account such factors as the material and strength of the wall, the status of the reinforcing material, and the possible changes that will take place over time.

- The cords must be connected to the Center Unit before attaching to a wall. (See page 4.)

1. Select the place where the Center Unit is to be attached.
2. Mount three screws (not supplied) on the wall. (See the diagram below for the details of the size.)
 - The supplied paper pattern will assist in determining the positions of the screws.

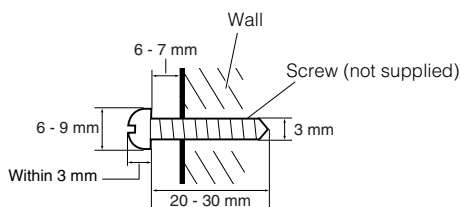

3. Hook the Center Unit onto the attached screws.
4. Slide the Center Unit to the side, and secure it.
 - Adjust the screws if the Center Unit is not attached firmly.

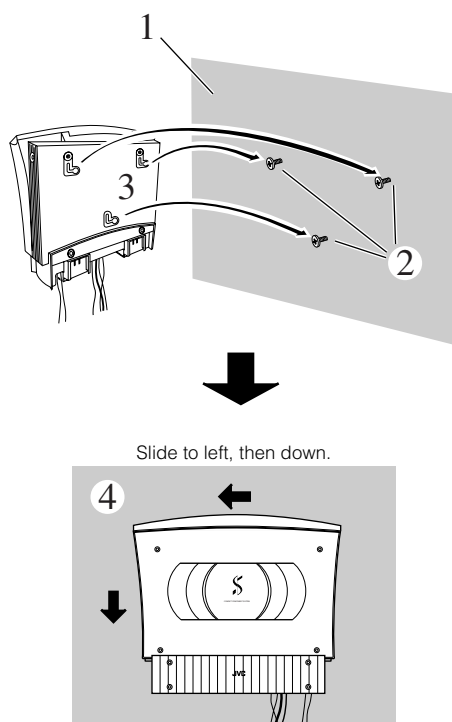

Getting Started

Example of attachment (Speakers)

The speakers can be attached to a wall.

Attach a screw (not supplied) on the wall, then hook the speaker onto the screw.

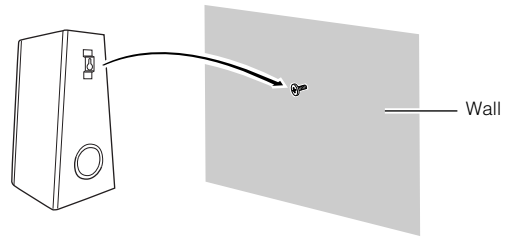

Notes

- Do not place anything on top of the Center Unit. Doing so may cause the Center Unit to fall, causing malfunctioning and/or injury.
- Do not climb onto the Center Unit or hang from it. Doing so may damage the Center Unit and/or cause injury. Special care must be taken in this respect when there are small children in the home.
- Avoid sandwiching the cords between the Center Unit and wall. This may upset the Center Unit's balance, causing the Center Unit to fall.
- Make sure that the cords will not interfere with daily activities and that the users will not trip over them. Do not pull the connected cords with excessive force.
- Check regularly that none of the screws are loose.
- In the event that the Center Unit has fallen, turn off the power, disconnect its power plug from the power outlet, and contact your dealer for an inspection and repairs. Continued use of the Center Unit may result in a fire or electric shocks.
- Do not place valuables (breakables) underneath the location where the Center Unit is attached. They will be damaged if the Center Unit should fall.
- The manufacturer accepts absolutely no liability for any accidents or damage resulting from inadequate assembly or mounting, insufficient strength of attachment, misuse or abuse, or natural disasters.

Now you can plug the AC power cord into the wall outlet, and your System is at your command!

Before operating, verify that the display shows the clock. If malfunctions may occur, reconnect the power cord.

Changing the Display and Control Buttons Settings

You can change the direction of the characters and symbols on the display and the assignment of the functions to each control button on the Unit. Change the settings depending on whether the Unit is placed vertically or horizontally. The factory setting is "V".

When the Unit is placed vertically

Set the DISP.SET switch to "V".

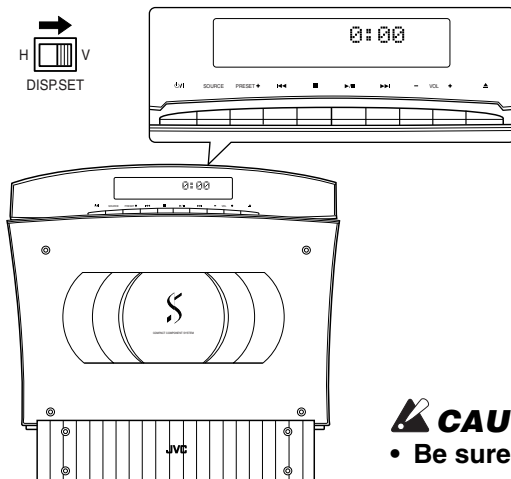

When the Unit is placed horizontally

Set the DISP.SET switch to "H".

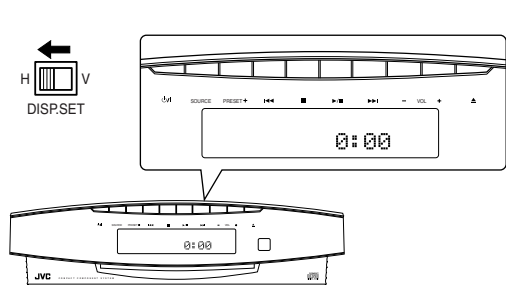

CAUTION:

- Be sure to turn off the System when changing the settings.

Using the Remote Control

The Remote Control makes it easy to use many of the functions of the System from a distance of up to 7 m away. The remote sensor at which you need to point the Remote Control differs depending on whether the Unit is placed vertically or horizontally.

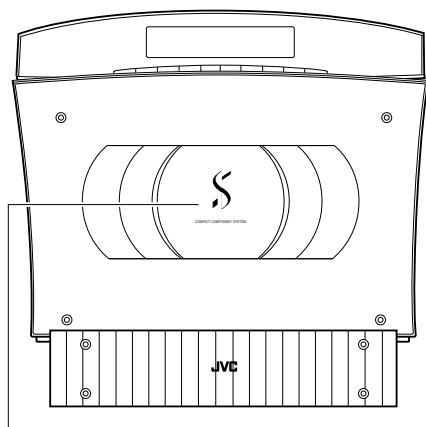

Remote sensor (when the Unit is placed vertically)

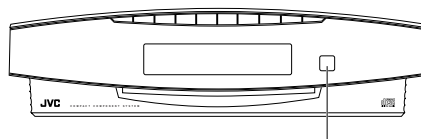

Remote sensor (when the Unit is placed horizontally)

- The maximum operating distance becomes short when the Panel is opened.



- Make sure that the "DISP.SET" switch on the rear of the Unit is set correctly.

COMPU Play

JVC's COMPU PLAY feature lets you control the most frequently used System functions with a single touch.

With One Touch Operation you can play a CD, turn on the radio, or listen to an external equipment with a single press of the play button for that function. One Touch Operation turns the power on for you, then starts the function you have specified. If the System is not ready (no CD in place), the System still powers on so you can insert a CD.

How One Touch Operation works in each case is explained in the section dealing with that function.

The COMPU PLAY buttons are:

On the Remote Control

- ▶/|| button
- FM/AM button
- MD/AUX button

On the Unit

- ▶/|| button
- SOURCE button
- The indicators for the buttons are invisible in Standby mode. Check the position of the buttons while the System is turned on.

Basic Operations

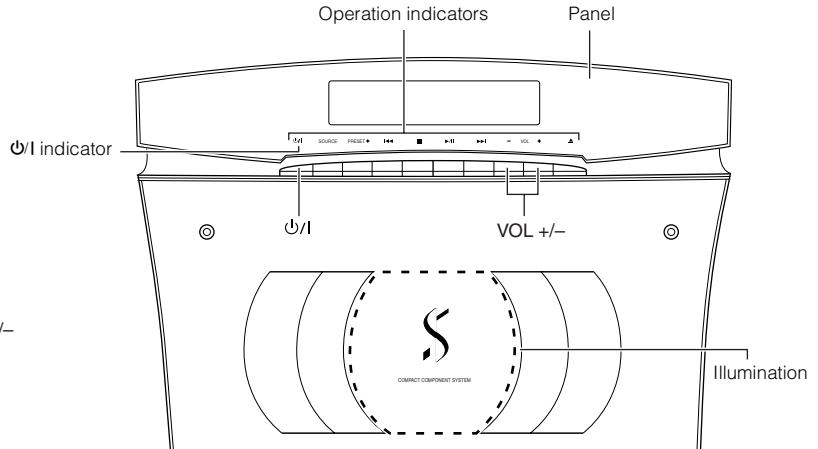
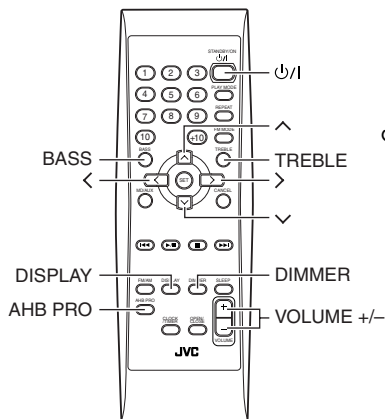

Turning the Power On and Off

Turning the System On

Press the ψ /I button.

The display comes on and “HELLO” is displayed once. The operation indicators light on the Panel. (The Panel opens automatically if the Unit is placed vertically and the DISP.SET switch on the rear of the Unit is set to “V”.)

The System comes on ready to continue in the mode it was in when the power was last turned off.

- For example, if the last thing you were doing was listening to a CD, you are now ready to listen to a CD again. If you wish, you can change to another source.

- If you were listening to the Tuner last, the Tuner comes on playing the station it was last set to.

Turning the System Off

Press the ψ /I button again.

The Panel closes if it has been opened. “GOOD BYE” is displayed and the display goes out, except for the clock display. The ψ /I indicator (red) remains lit and the rest of the operation indicators go out.

- Some power is always consumed even though power is turned off (called Standby Mode).

- To switch off the System completely, unplug the AC power cord from the wall outlet. When you unplug the AC power cord, the clock will be reset to 0:00 after about 20 minutes.

Power Save Mode

You can reduce the power consumption in standby mode.

Press the DISPLAY button on the Remote Control when the System is turned off.

- The clock display goes out.

CD-in indicator

While a disc is loaded on the Unit, the CD-in indicator is lit on the display.



- The CD-in indicator lights while using the Tuner or external equipment and does not light during CD operations.

Adjusting the Brightness (DIMMER)

(Using the Remote Control)

You can adjust the brightness of the backlighting for the display and the illumination on the cover.

When the System is Turned On

Each time you press the DIMMER button on the Remote Control, the brightness of the backlighting and the illumination on the cover change as follows:



Display	Backlighting	Illumination
DIMMER OFF	Bright	Bright
DIMMER 1	Slightly Dark	Slightly Dark
DIMMER 2	Dark	Off

Note

- When the System is turned off once, then turned on again, the brightness setting will be restored to the previous one since the setting is stored in memory.

Adjusting the Volume

To increase the volume, press the VOLUME + button on the Remote Control (or VOL + button on the Unit).
To decrease the volume, press the VOLUME – button on the Remote Control (or VOL – button on the Unit).

VOLUME 15

You can adjust the volume level between 0 and 50.

CAUTION:

- **DO NOT** turn off the System with the volume set to an extremely high level; otherwise a sudden blast of sound could damage your hearing, speakers and/or headphones when you turn on the System or start playing any source next time. **REMEMBER** you cannot adjust the volume level while the System is in standby mode.

For private listening

Connect a pair of headphones to the PHONES jack. No sound comes out of the speakers.
Be sure to turn down the volume before connecting or putting on headphones.

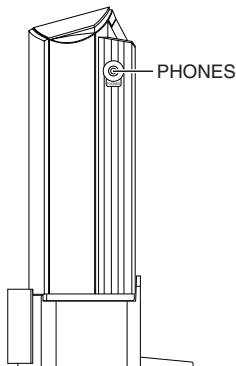

Reinforcing the Bass Sound (AHB PRO)

(Using the Remote Control)

You can reinforce the bass sound to maintain rich, full bass at low volume.

To get the effect, press the AHB (Active Hyper Bass) PRO button.

The “AHB PRO” indicator lights up on the display.

To cancel the effect, press the button again.

The “AHB PRO” indicator goes out.

Tone Control (BASS/TREBLE)

(Using the Remote Control)

You can control the tone by changing the bass and treble.

BASS Control

You can adjust the bass level (low frequency range level) between –5 and +5. (0: Flat)

- 1 Press the **BASS** button on the Remote Control.

- 2 Press the **^** or **v** button on the Remote Control to adjust the bass level.

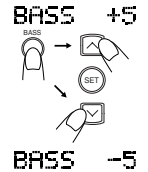

TREBLE Control

You can adjust the treble level (high frequency range level) between –5 and +5. (0: Flat)

- 1 Press the **TREBLE** button on the Remote Control.

- 2 Press the **^** or **v** button on the Remote Control to adjust the treble level.

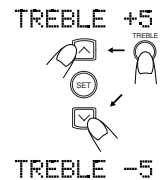

Note

- Press the **^** or **v** button within 5 seconds to adjust the level after pressing the BASS or TREBLE button.

Showing the Time (DISPLAY)

(Using the Remote Control)

You can show the current time on the display.

To display the clock, press the DISPLAY button on the Remote Control.

To return to the previous mode, press the same button again.

7:00

Note

- To let the clock work, you need to set the clock first. (See “Setting the Clock” on page 20.)

Using the Tuner

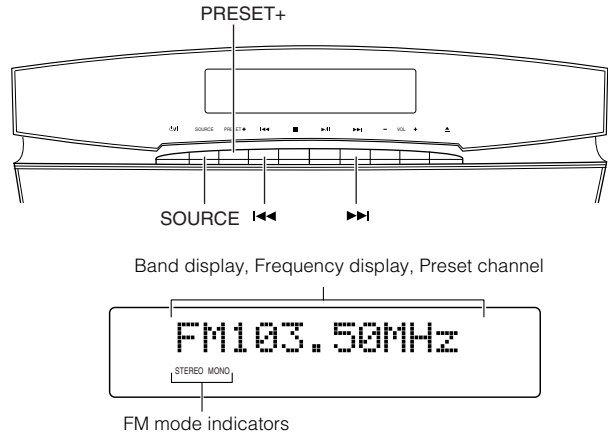
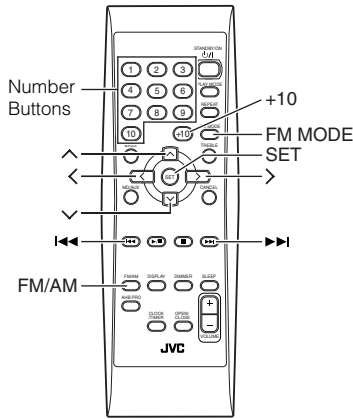

* When the System is in use, the display shows other items as well.
 For simplicity, we show here only the items described in this section.

You can listen to FM and AM stations. Stations can be tuned in manually, automatically, or from preset memory storage.

- Before listening to the radio:
 - Make sure that both the FM and AM antennas are correctly connected. (See page 4 and 5.)

One Touch Radio

Just press the FM/AM button on the Remote Control to turn on the System and start playing the station you were last tuned to.

- You can switch from any other sound source to the radio by pressing the FM/AM button on the Remote Control (or the SOURCE button on the Unit).

Tuning In a Station

1 Press the FM/AM button.

The Band and Frequency you were last tuned to appear on the display.

(If the last station was selected using the preset number, the preset number appears first.)

Each time you press the button, the band alternates between FM and AM.

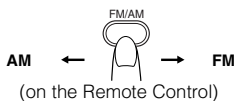

● Using the SOURCE button on the Unit

Each time you press the button, the sound source changes.

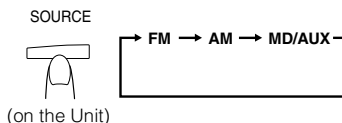

2 Select a station using one of the following methods.

● Manual Tuning

Press the ◀◀ or ▶▶ (∧ or ∨) button repeatedly to move from frequency to frequency until you find the station you want.

OR

● Auto Tuning

If you press and hold the ◀◀ or ▶▶ (∧ or ∨) button for one second or more, the frequency changes down, or up, automatically until a station is found.

OR

● Preset Tuning using the Remote Control (Possible only after presetting stations)

Select the desired preset number using the Number buttons on the Remote Control. (For the preset number more than 10, press the +10 button then the Number button.) After 1 second the display will show the preset number's band and frequency.

Example:

Press the +10 button then the 2 button continuously. The preset number 12 "P12" appears.

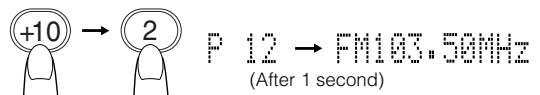

● Preset Tuning using the Unit

Press the PRESET+ button to select the desired preset number.

Its band and frequency are displayed.

Note

- In AM broadcast, reception sensitivity will be changed by turning the AM loop antenna. Turn the AM loop antenna for best reception.

Presetting Stations

(Using the Remote Control)

You can preset up to 30 FM stations and up to 15 AM stations.



- Preset numbers may have been set to factory test frequencies prior to shipment. This is not a malfunction. You can preset the stations you want into memory by following one of the presetting methods below.

Manual Presetting

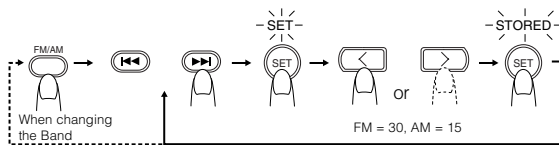

- 1 Select a band by pressing the FM/AM button.**
- 2 Press the ◀◀ or ▶▶ (∧ or ∨) button to tune in a station.**
- 3 Press the SET button.**
 “SET” will blink for 5 seconds.
 Within 5 seconds, proceed to the next step.
 When the display returns to the one set in step 2 after 5 seconds, press the SET button again.
- 4 Press the > or < button within 5 seconds to select the preset number.**
 > or < button: Increase or decrease the preset number by 1.
 Pressing and holding the button will rapidly increase or decrease the preset number.
- 5 Press the SET button within 5 seconds.**
 “STORED” appears and after 2 seconds, the display returns to the broadcast frequency display.
- 6 Repeat above steps 1 to 5 for each station you want to store in memory with a preset number.**
 To change the preset stations, repeat the same steps as above.

⚠ CAUTION:

- Even if the system is unplugged or if the power failure occurs, the preset stations will be stored for about 24 hours. However, in case the preset stations are erased, you will need to preset the stations again.

To Change the FM Reception Mode

(Using the Remote Control)

When you are tuned into an FM stereo broadcast, the “STEREO” indicator lights up and you can hear stereo effects.

If an FM stereo broadcast is hard to receive or noisy, you can select Monaural mode. Reception improves, but you lose stereo effect.

Press the FM MODE button on the Remote Control so that the “MONO” indicator lights up on the display.

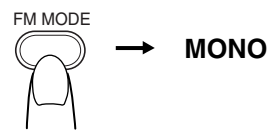

To restore the stereo effect, press the FM MODE button on the Remote Control so that the “MONO” indicator goes off.

Using the CD Player

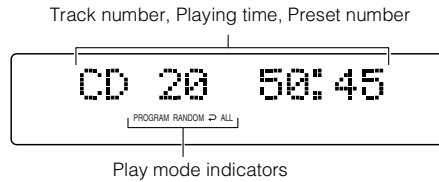
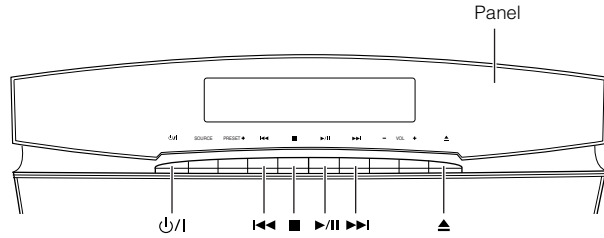
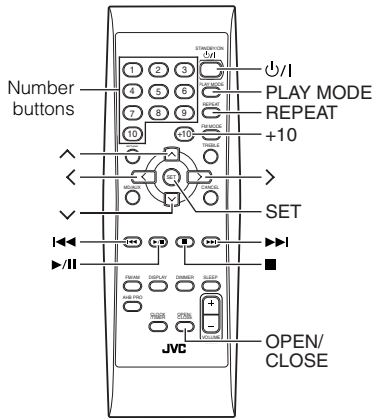

* When the System is in use, the display shows other items as well.
 For simplicity, we show here only the items described in this section.

You can use Normal, Random, Program or Repeat Play. Repeat Play can repeat all the tracks or just one of the tracks on the CD.

Here are the basic things you need to know to play a CD and locate the different tracks on it.

This unit has been designed to play back the following CDs.

- CD
- CD-R
- CD-RW

When playing a CD-R or CD-RW

You can play back **finalized CD-R or CD-RW** recorded music CD format.

- You can play back CD-R or CD-RW like CD.
- Some CD-R or CD-RW may not be played back on this unit because of their disc characteristics, damage or stain on them, or if the player lens is dirty.
- The reflection factor of CD-RW is lower than that of other CD, possibly causing CD-RW to take longer to read.

The Quickest Way To Start a CD Is With the One Touch Operation

- Press the >>>> button on the Remote Control.
 - The power is automatically turned on. If a CD is already inserted, it will start playing from the first track.
 - If no CD is inserted, "CD NO DISC" appears on the display and the CD Player remains in Stop mode.

To Insert a CD

1 Press the ⏻/⏹ button.

(When the Unit is placed vertically)

The Panel opens automatically.

(When the Unit is placed horizontally)

To open the Panel, press the ▲ button on the Unit or the OPEN/CLOSE button on the Remote Control.

2 Insert a CD into the loading slot, with its label side front or up as shown below.

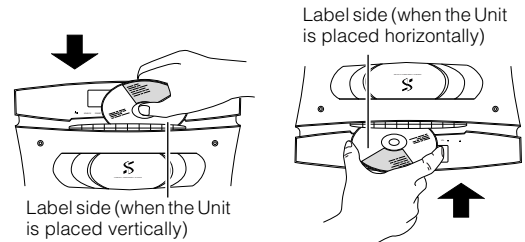

- An 8 cm (3") CD cannot be played back in this Unit. (Do not attempt to insert an 8 cm (3") CD using an adapter. Doing so will damage the Unit.)
- If the CD cannot be read correctly (because it is scratched or loaded upside down, for example), "CANNOT PLAY" appears on the display.
- You can insert a CD while listening to the other source.

⚠ CAUTIONS:

- DO NOT try to open or close the Panel by hands as it will be damaged. Press the OPEN/CLOSE button on the Remote Control to open or close the Panel.
- DO NOT try to insert another CD when a CD has been already loaded on the Unit. Doing so will damage the CDs and the Unit.
- DO NOT apply any shock to the Panel when it is open.
- DO NOT clean the Panel when it is open.

To Unload a CD

Press the ▲ button on the Unit to eject a CD. The CD is ejected automatically, then take out the CD.

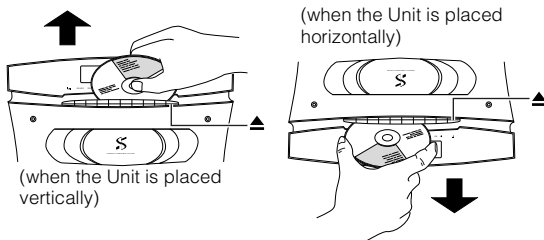

Basics of Using the CD Player — Normal Play

To Play a CD

1 Insert a CD.

2 Press the ►/|| button.

The first track of the CD begins playing.

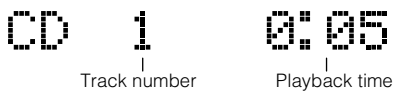

- The CD Player automatically stops when the last track of the CD has finished playing.

To stop playing the CD, press the ■ button. The following information for the CD is displayed.

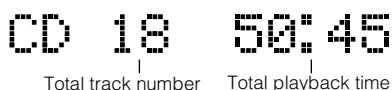

To stop playing and remove the CD, press the ▲ button on the Unit.

To pause, press the ►/|| button. The playback time blinks on the display.

To cancel pause, press the same button again. Play continues from the point where it was paused.

To Select a Track or Passage within a Track

In the stop mode or during playback, press the Number button on the Remote Control to select the track you want.

- The selected track starts playing.
- For the track number more than 10, press the +10 button then the Number button.

OR

During playback, press the ◀◀ or ▶▶ button to select the track you want.

- The selected track starts playing.
- Press the ▶▶ button once to skip to the beginning of the next track.
- Press the ◀◀ button to skip to the beginning of the track being played. Press twice quickly to skip to the beginning of the previous track.

Search Play

Holding down the ◀◀ or ▶▶ button, during playback, will fast forward/backwards the CD so you can quickly find a particular passage in the track you are listening to.

Note

- The < or > and ^ or v buttons on the Remote Control operate same as the ◀◀ or ▶▶ button does.

Programming the Playing Order of the Tracks

(Using the Remote Control)

You can program the playing order of the tracks.

- You can program up to 32 tracks in any desired order including the same tracks.
- You can only make a program when the CD Player is stopped.

1 Insert a CD.

2 Press the ►/|| button.

3 Press the ■ button to stop the CD.

4 Press the PLAY MODE button on the Remote Control until the “PROGRAM” indicator lights up.



(To be continued on the next page)

5 Press the Number button to select the track to program.

Each time you press the Number button, the selected track is added to the program.

- For the track number more than 10, press the +10 button then the Number button.

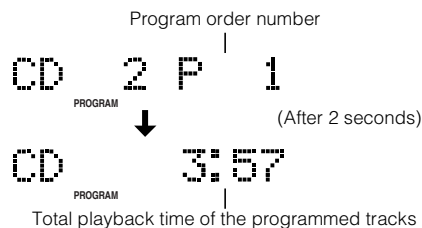

6 Repeat step 5 to select the other tracks for the program.

You can see the total playback time of programmed tracks on the display.

7 Press the ►/II button.

The System plays the tracks in the order you have programmed them.

- You can skip to a particular program track by pressing the ◀◀ or ▶▶ button during Program Play.

- To stop playing, press the ■ button once.

To confirm the programmed tracks while the CD player is stopped, each time press the ◀◀ or ▶▶ button; the tracks making up the program will successively be displayed in the programmed order.

To exit the program mode once, while the CD Player is stopped, press the PLAY MODE button to light off the “PROGRAM” indicator.



- If the total playback time of the programmed tracks exceeds 99 minutes 59 seconds, “-- : --” will appear on the display.

To Modify the Program

Modify the contents of the program while the CD Player is stopped.

Each time you press the CANCEL button, the last track in the program is deleted. To add new tracks to the end of the program, repeat above step 5.

- To delete the all tracks in the program, press the CANCEL button for over 2 seconds.

Random Play

(Using the Remote Control)

The tracks will play in no special order when you use this mode.

- To enter Random Play mode, stop playback first.

1 Press the PLAY MODE button on the Remote Control until the “RANDOM” indicator lights.

2 Press the ►/II button.

The tracks are played in random order.

To skip a track during playback, press the ▶▶ button to jump to the next track in the random sequence. Press the ◀◀ button to jump back to the start of a track being played.

To exit Random Play mode, while the CD Player is stopped, press the PLAY MODE button to light off the “RANDOM” indicator and carry out Normal Play.

Repeating Tracks

(Using the Remote Control)

You can repeat all tracks or individual track, as many times as you like.

Press the REPEAT button on the Remote Control.

The Repeat indicator changes with each press of the button, as shown below.

⏮ → ⏮ ALL → blank display → (back to the beginning)

⏮ : Repeats one track.

⏮ ALL: In Normal Play mode, repeats all the tracks.
In Program Play mode, repeats all the tracks in the program.
In Random Play mode, repeats all the tracks in random order.

To exit Repeat mode, press the REPEAT button until the Repeat indicator on the display goes out.

- Repeat mode remains in effect even when you change the play mode.

Child Lock

You can prevent the unwanted CD ejection by locking.

- Before proceeding, check the position of the ▶▶ button on the Unit, then **turn off the System.**

To Lock the CD Ejection

Hold down the ▶▶ button and press the ⏻ button on the Unit.

“LOCKED” appears on the display.

To Release the Lock

Perform the same procedure when you locked.

“UNLOCKED” appears on the display.

Using External Equipment

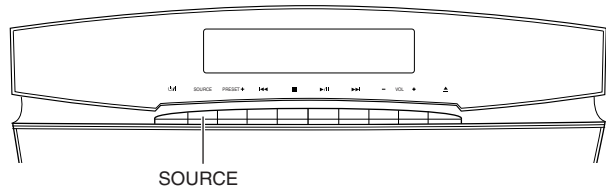
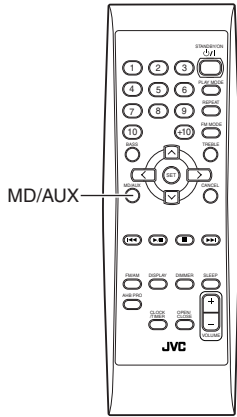

Listening to External Equipment

You can listen to external equipment such as MD recorder, cassette deck or other auxiliary.

- First make sure that the external equipment is properly connected to the System. (See page 7.)

1 Press the MD/AUX button.

“MD/AUX” appears on the display.

MD/AUX

- On the Unit, press the SOURCE button until “MD/AUX” appears on the display.

2 Start playing the external equipment.

Note

- For operation of the external equipment, refer to its Instructions.

Recording the System's Source to External Equipment

You can record the System's source to external equipment which is connected to the MD/AUX-IN/OUT or CD DIGITAL OUT terminals of the System, such as cassette deck or MD recorder, etc.

- First make sure that the external equipment is properly connected to the System. (See page 7.)

1 Play the System's CD Player or tune in to a station.

- The recording level is not affected by the VOLUME level set by the System. Also it is not affected by the sound effects.

Notes

- For operation of the external equipment, refer to its Instructions.
- While using the tuner, no signals come out from the CD DIGITAL OUT terminal.

Using the Timers

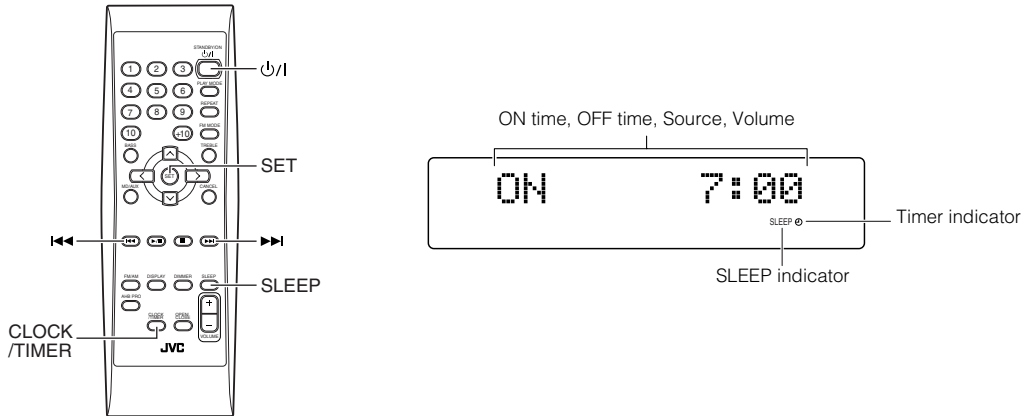

* When the System is in use, the display shows other items as well.
For simplicity, we show here only the items described in this section.

The timers let you control listening functions automatically.

Setting the Clock

(Using the Remote Control)

- When you plug the AC power cord into the wall outlet, the time indication “0:00” blinks on the display.



- The clock must be correctly set for the timers to work.

1 Press the **ON/OFF** button.

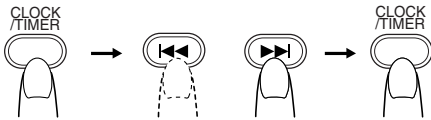

2 Press the **CLOCK/TIMER** button on the Remote Control.

The hour digit of the time indication rapidly blinks on the display.

3 Press the **▶▶** or **◀◀** button on the Remote Control to set the hour.

Pressing the **▶▶** button moves the time forwards and pressing the **◀◀** button moves it backwards. Hold down the button to move the time rapidly.

4 Press the **SET** button.

The minute digits of the time indication rapidly blink on the display.

5 Press the **▶▶** or **◀◀** button to set the minute.

6 Press the **SET** button.

The selected time is set and the seconds start counting from 0.

CAUTION:

- If there is a power failure, the clock loses its setting after about 20 minutes. “0:00” blinks on the display and the clock must be reset.



- The clock may gain or lose one to two minutes per month.
- The **▲** or **▼** button operates same as the **▶▶** or **◀◀** button does.

Setting the Daily Timer

(Using the Remote Control)

Once you have set the Daily Timer, the timer will be activated at the same time every day.

The Timer indicator (☉) on the display shows that the Daily Timer you have set is in effect.

- When the Timer Indicator (☉) is displayed, the timer is activated.
- When the Timer Indicator (☉) is not displayed, the timer is deactivated.

1 Setting the ON time (Example: 10:15).

1. Press the CLOCK/TIMER button on the Remote Control.
"TIMER" appears on the display.

TIMER

- When the clock is not set, "0:00" appears on the display. Set the clock first.
2. Press the CLOCK/TIMER button again. The hour digit of the "ON" time blinks on the display.

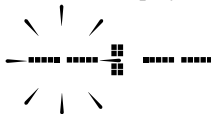
ON 

Press the ►► or ◄◄ button on the Remote Control to set the hour you want the Unit to come on.

Pressing the ►► button moves the time forwards and pressing the ◄◄ button moves it backwards. Hold down the button to move the time rapidly.

ON 

3. Press the SET button.
The minute digits of the ON time blink on the display.

ON 

Set the minute you want the Unit to come on, using the ►► or ◄◄ button.

ON 

2 Setting the OFF time (Example: 13:30).

1. Press the SET button.
The hour digit of the OFF time blinks on the display. (The same time as the ON time will be automatically set.)

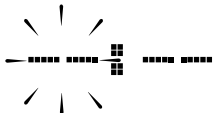
OFF 

Set the hour you want the Unit to be turned off, using the ►► or ◄◄ button.

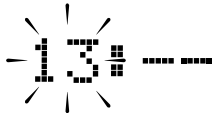
OFF 

2. Press the SET button.
The minute digits of the OFF time blink on the display.

OFF 

Set the minute you want the Unit to be turned off, using the ►► and ◄◄ buttons.

OFF 

3 Selecting the music source.

1. Press the SET button.
The "TUNER" or "CD" blinks on the display.
2. Press the ►► or ◄◄ button to select the music source you want to listen to.
The display changes as shown below.
TUNER◄CD►(back to the beginning)

4 Setting the volume level.

1. Press the SET button.
The current volume setting blinks on the display.
2. Press the ►► or ◄◄ button to select the volume level.
-- : The current volume level will be used.
0 to 50 : When the timer is turned on, the Volume will be automatically set to the selected level.

VOLUME 

5 Press the SET button.

The timer setting is completed and the Timer indicator (☉) appears on the display. The display shows the each setting of the Timer and returns to the display before you set the Timer.

(To be continued on the next page)

6 Before turning off the System, prepare the music source selected in step 3.

TUNER: Tune in to the desired station.

CD: Insert a CD. (Playback will start from the first track at Timer on.)

7 Press the button to turn off the System.

In standby mode, you can see the Timer indicator () on the display.

- When the timer turns on, the Timer indicator starts blinking and the prepared source in step 6 will be played.

To confirm the timer setting

Press the CLOCK/TIMER button, then press the SET button. Each setting appears on the display.

To cancel the timer

Press the CLOCK/TIMER button, then press the CANCEL button. The Timer indicator () goes out.

To re-activate the cancelled timer

Press the CLOCK/TIMER button, then press the SET button. The Timer indicator () appears.

To change the timer setting

Repeat the setting procedure from the beginning.

CAUTION:

- If the System is unplugged, or a power failure occurs, the timer setting will be lost. You will need to reset the clock first, then the timer.

Setting the SLEEP Timer

(Using the Remote Control)

Use the Sleep Timer to turn the System off after a certain number of minutes when it is playing. By setting the Sleep Timer, you can fall asleep to music and know that your System will turn off by itself rather than play all night.

- You can only set the Sleep Timer when the System is on and a source is playing.

1 Play a CD or tune in to the desired station.

2 Press the SLEEP button on the Remote Control.

The “SLEEP” indicator lights up.

- When the clock is not set, “0:00” appears on the display. Set the clock at first.

3 Set the length of time you want the source to play before shutting off.

- Each time you press the SLEEP button, it changes the number of minutes shown on the display in this sequence:

10 → 20 → 30 → 60 → 90 → 120 → Cancelled → (back to the beginning)

The selected number of minutes for the Sleep Timer will disappear five seconds later and the display returns to the original one before setting the Sleep Timer. (The display is dimmed.)

The System is now set to turn off after the number of minutes you set.

To Confirm the Sleep Time:

When the SLEEP button is pressed, the remaining sleep time is displayed. Wait until the display returns to the original display.

To Cancel the SLEEP Timer Setting:

Press the SLEEP button until the “SLEEP” indicator goes out on the display.

Turning off the System also cancels the SLEEP Timer.

- If you are setting the Daily Timer, the System will be turned on at the set time to wake you up.

Care And Maintenance

Handle your CDs carefully, and they will last a long time.

Compact Discs

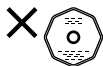

- Only CDs bearing this mark can be used with this System. However, continued use of irregular shape CDs (heart-shape, octagonal, etc.) can damage the System.
- Do not stick a paper tape or a seal on the reading side or the label side. If you do so, the CD may not be unloaded, or the System can be damaged.



- Remove the CD from its case by holding it at the edges while pressing the case's center hole lightly.
- Do not touch the shiny surface of the CD, or bend the CD.



- Put the CD back in its case after use to prevent warping.
- Be careful not to scratch the surface of the CD when placing it back in the case.
- Avoid exposure to direct sunlight, temperature extremes, and moisture.



- A dirty CD may not play correctly. If a CD does become dirty, wipe it with a soft cloth in a straight line from center to edge.

CAUTION:

- Do not use any solvent (for example, conventional record cleaner, spray thinner, benzene, etc.) to clean a CD.

Moisture Condensation

Moisture may condense on the lens inside the System in the following cases:

- After turning on heating in the room.
- In a damp room.
- If the System is brought directly from a cold to a warm place.

Should this occur, the System may malfunction. In this case, leave the System turned on for a few hours until the moisture evaporates, unplug the AC power cord, and then plug it in again.

General Notes

In general, you will have the best performance by keeping your CDs and the mechanism clean.

- Store CDs in their cases, and keep them in cabinets or on shelves.
- Keep the System's Panel closed when not in use.

Cleaning the unit

- Stains on the unit
Should be wiped off with a soft cloth. If the unit is heavily stained, wipe it with a cloth soaked in water-diluted neutral detergent and wrung well, then wipe clean with a dry cloth.
- Since the unit may deteriorate in quality, become damaged or get its paint peeled off, be careful about the followings.
 - DO NOT wipe it with a hard cloth.
 - DO NOT wipe it strong.
 - DO NOT wipe it with thinner or benzene.
 - DO NOT apply any volatile substance such as insecticides to it.
 - DO NOT allow any rubber or plastic to remain in contact with it for a long time.

Troubleshooting

- If you are having a problem with your System, check this list for a possible solution before calling for service.
- If you cannot solve the problem from the hints given here, or the System has been physically damaged, call a qualified person, such as your dealer, for service.

Symptom	Possible Cause	Action
No sound is heard.	<ul style="list-style-type: none"> • Connections are incorrect, or loose. • Headphones are connected. 	<ul style="list-style-type: none"> • Check all connections and make corrections. (See pages 4 to 8.) • Disconnect the headphones.
Poor radio reception	<ul style="list-style-type: none"> • The antenna is disconnected. • The AM Loop Antenna is too close to the System. • The FM Wire Antenna is not properly extended and positioned. 	<ul style="list-style-type: none"> • Reconnect the antenna securely. • Change the position and direction of the AM Loop Antenna. • Extend FM Wire Antenna to the best reception position.
The CD skips.	The CD is dirty or scratched.	Clean or replace the CD.
The CD does not play.	The CD is upside down.	Put the CD in with the label side up.
Unable to operate the Remote Control.	<ul style="list-style-type: none"> • The path between the Remote Control and the sensor on the Unit is blocked. • The batteries have lost their charge. 	<ul style="list-style-type: none"> • Remove the obstruction. • Replace the batteries.
Operations are disabled.	The built-in microprocessor has malfunctioned due to external electrical interference.	Unplug the System then plug it back in.
“CD NO DISC” appears.	There is no disc loaded.	Insert a disc.
“CANNOT PLAY” or “UNFINALIZ” appears.	<ul style="list-style-type: none"> • The CD-R or CD-RW that hasn’t yet been finalized (including blank discs) has been inserted. • The disc has been inserted with its label side down. 	<ul style="list-style-type: none"> • Insert a CD-R or CD-RW that has been finalized. • Remove the disc and insert it with the label side front or up. (See page 16.)
The characters and symbols on the display appear upside down.	The DISP.SET switch on the rear panel of the Center Unit has not been set correctly.	Set the DISP.SET switch correctly. (See page 10.)

Specifications

CA-VSDT6

Amplifier

Output Power	38 W (19 W + 19 W) at 4 Ω (Max.) 30 W (15 W + 15 W) at 4 Ω (10 % THD)
Input Sensitivity/Impedance (1 kHz)	
MD/AUX IN	500 mV/47 kΩ
Output Sensitivity/Impedance (1 kHz)	
MD/AUX OUT	500 mV/5 kΩ
CD DIGITAL OUT (Optical out)	-21 dBm - -15 dBm
Speaker terminals	4 Ω - 16 Ω
Subwoofer out	440 mV/6 kΩ
Phones	16 Ω - 1 kΩ
	0 - 15 mW/ch output into 32 Ω

CD Player

Signal-To-Noise Ratio	100 dB (typical)
Wow And Flutter	Unmeasurable

Tuner

FM Tuner	
Tuning Range	87.5 MHz - 108.0 MHz
AM Tuner	
Tuning Range	522 kHz - 1 710 kHz

Power Specifications

Power Requirements	AC 240 V ~, 50 Hz
Power Consumption	36 W (power on mode) 2.5 W (power save mode)

Center Unit

Dimensions*	325 mm × 86 mm × 237 mm (W/H/D)
Mass*	Approx. 3.9 kg

* without Stand and Legs

Speaker Specifications (each unit)

SP-VSDT6

Speakers	8 cm cone
Impedance	4 Ω
Dimensions	124 mm × 255 mm × 124 mm (W/H/D)
Mass	1.4 kg

Accessories

- Power Cord (1)
- AM Loop Antenna (1)
- Remote Control (1)
- Batteries R6P (SUM-3)/AA (15F) (2)
- FM Wire Antenna (1)
- Speaker Cords (2)
- Stand (1) (for Center Unit)
- Legs (2) (for Stand)
- Screw (1) (for Stand)
- Paper Pattern (1)

Dimensions for Installation (CA-VSDT6)

Vertical Position

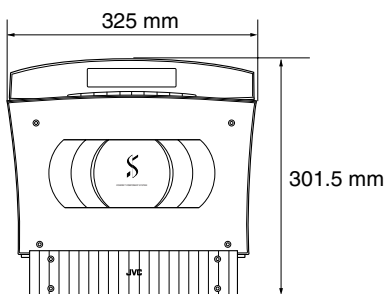

(On the wall)

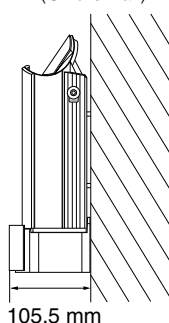

(With Legs)

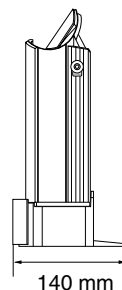

Horizontal Position

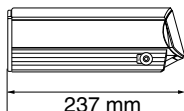
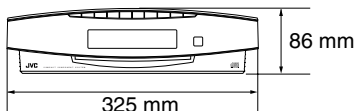

Design and specifications are subject to change without notice.



JVC
VICTOR COMPANY OF JAPAN, LIMITED

CAUTION/VORSICHT/ATTENTION/OPGELET/CUIDADO/ ATTENZIONE/FÖRSIKRIGT/MUISTA/FORSIGTIG

- Insert a disc with its label side front.
- Legen Sie eine Disc mit der Etikettseite nach außen ein.
- Introduisez un disque avec sa face portant l'étiquette vers l'avant.
- Plaats een disc met de labelkant naar voren erin.
- Inserte un disco con su cara impresa hacia delante.
- Inserire un disco con il lato dell'etichetta rivolto in avanti.
- Sätt i en skiva, med etikettsidan vänd framåt.
- Aseta levy paikoilleen etikettipuoli eteenpäin.
- Indsæt en disk med etiketsiden udad.

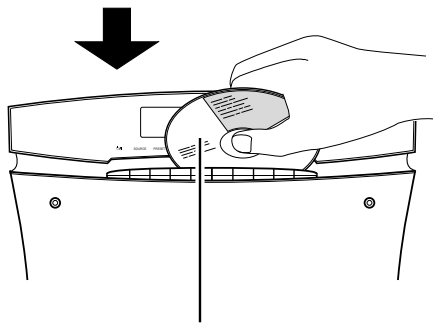

Label side
Etikettseite
Face portant l'étiquette
Labelkant
Cara impresa
Lato dell'etichetta
Etikettsida
Etikettipuoli
Etiketside

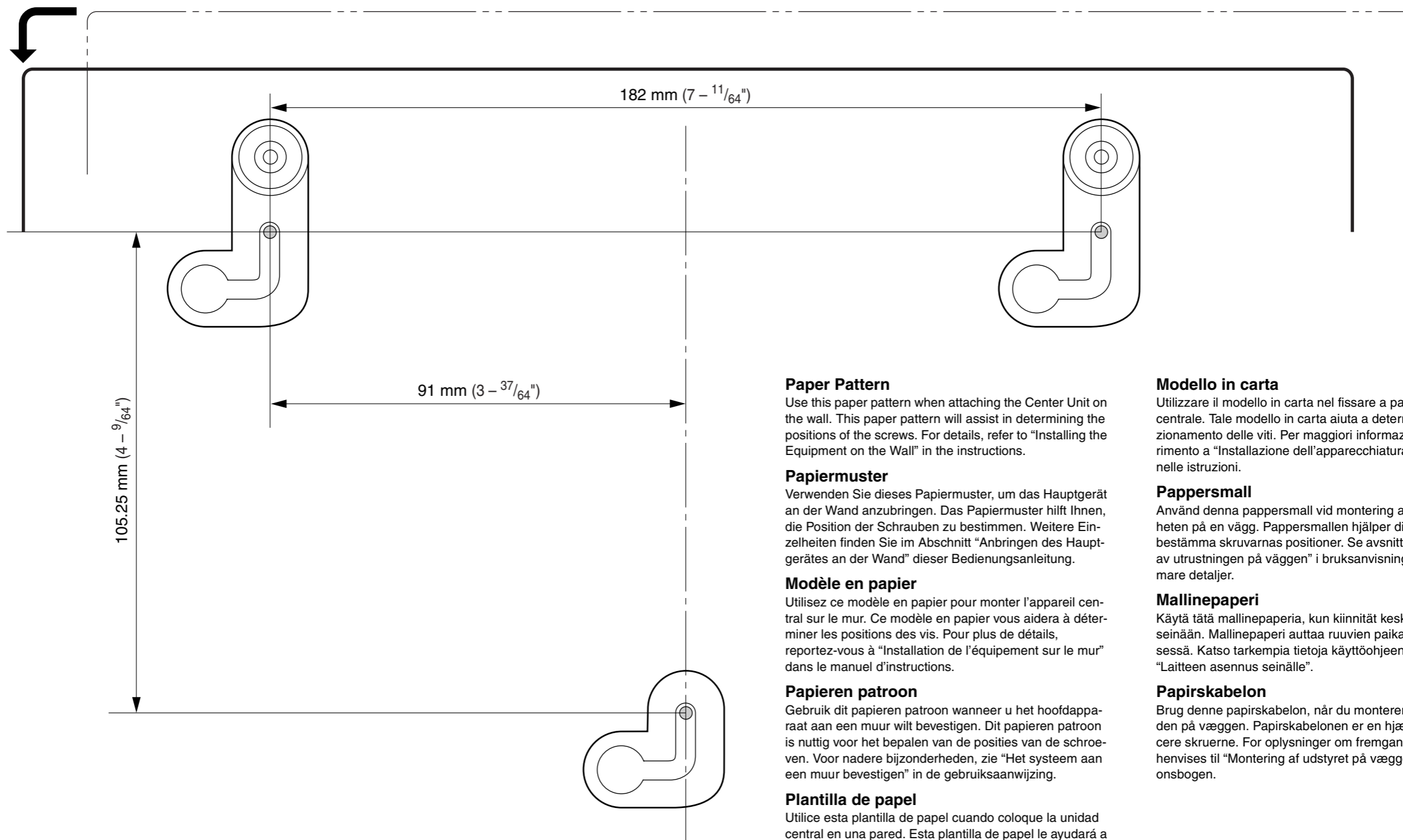

Paper Pattern

Use this paper pattern when attaching the Center Unit on the wall. This paper pattern will assist in determining the positions of the screws. For details, refer to "Installing the Equipment on the Wall" in the instructions.

Papiermuster

Verwenden Sie dieses Papiermuster, um das Hauptgerät an der Wand anzubringen. Das Papiermuster hilft Ihnen, die Position der Schrauben zu bestimmen. Weitere Einzelheiten finden Sie im Abschnitt "Anbringen des Hauptgerätes an der Wand" dieser Bedienungsanleitung.

Modèle en papier

Utilisez ce modèle en papier pour monter l'appareil central sur le mur. Ce modèle en papier vous aidera à déterminer les positions des vis. Pour plus de détails, reportez-vous à "Installation de l'équipement sur le mur" dans le manuel d'instructions.

Papieren patroon

Gebruik dit papieren patroon wanneer u het hoofdapparaat aan een muur wilt bevestigen. Dit papieren patroon is nuttig voor het bepalen van de posities van de schroeven. Voor nadere bijzonderheden, zie "Het systeem aan een muur bevestigen" in de gebruiksaanwijzing.

Plantilla de papel

Utilice esta plantilla de papel cuando coloque la unidad central en una pared. Esta plantilla de papel le ayudará a determinar las posiciones de los tornillos. Para conocer detalles, consulte "Instalación del equipo en una pared" en el manual de instrucciones.

Modello in carta

Utilizzare il modello in carta nel fissare a parete l'unità centrale. Tale modello in carta aiuta a determinare il posizionamento delle viti. Per maggiori informazioni, fare riferimento a "Installazione dell'apparecchiatura a parete", nelle istruzioni.

Pappersmall

Använd denna pappersmall vid montering av centralenheten på en vägg. Pappersmallen hjälper dig att bestämma skruvarnas positioner. Se avsnittet "Montering av utrustningen på väggen" i bruksanvisningen för närmare detaljer.

Mallinepaperi

Käytä tätä mallinepaperia, kun kiinnität keskuslaitteen seinään. Mallinepaperi auttaa ruuvien paikan määrittämisessä. Katso tarkempia tietoja käyttöohjeen kohdasta "Laitteen asennus seinälle".

Papirskabelon

Brug denne papirskabelon, når du monterer centerenheden på væggen. Papirskabelonen er en hjælp til at placere skruerne. For oplysninger om fremgangsmåden henvises til "Montering af udstyret på væggen" i instruktionsbogen.